

Edward

L2000

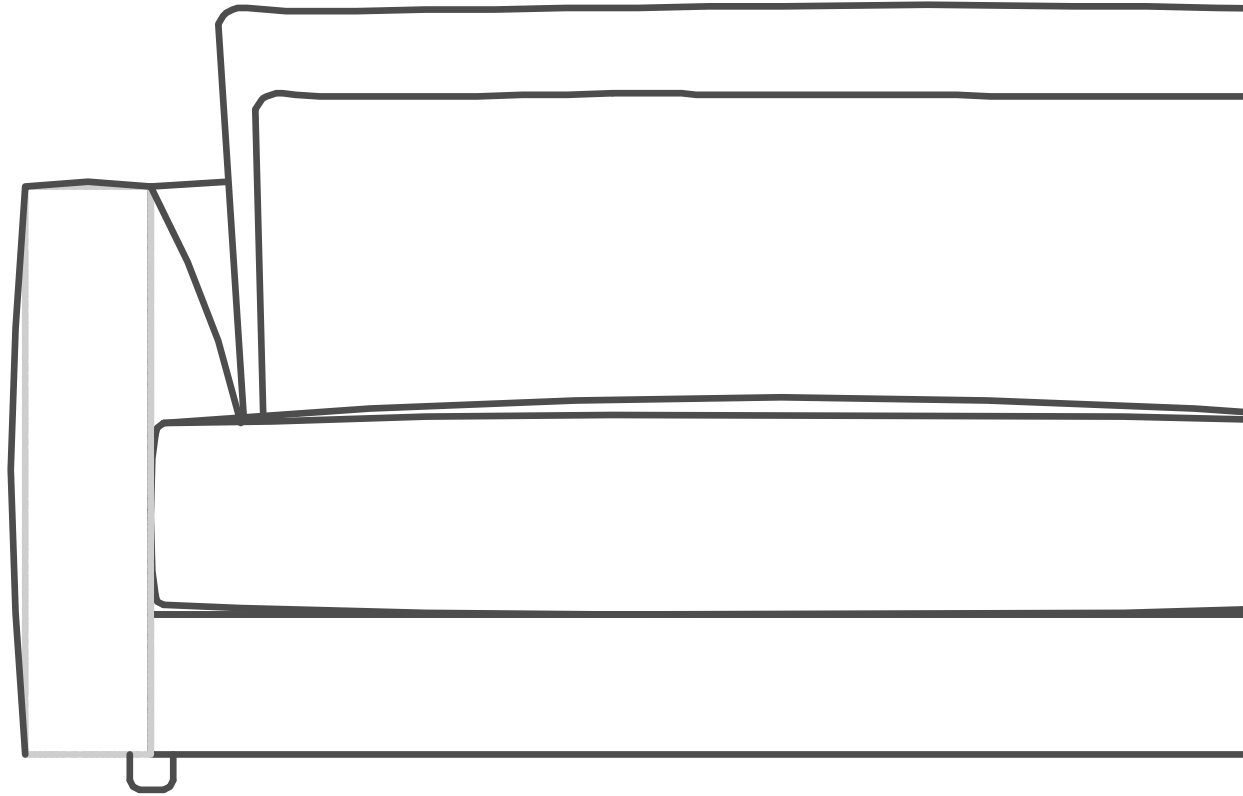

TECHNICAL DESCRIPTION

FRAME:	SELECT KILN DRIED HARDWOOD AND BC FIR PLYWOOD COVERED WITH POLYURETHANE FOAM AND POLYESTER FIBER.
SUSPENSION:	WEBBING, MADE IN ITALY
SEAT CUSHIONS:	HIGH-DENSITY POLYURETHANE FOAM WRAPPED WITH 90/10 CANADIAN GOOSE FEATHER AND DOWN.
BACK CUSHIONS:	90/10 CANADIAN GOOSE FEATHER / DOWN & POLYESTER FIBER BLEND.
UPHOLSTERY:	UPHOLSTERED IN A SELECT VARIETY OF FABRICS AND FULL GRAIN LEATHERS. ALL EDGES ARE SERGED AND TOP STITCHED.
FURNITURE:	MADE OF HIGH QUALITY AMERICAN BLACK WALNUT VENEER

huppé®

Edward

L2000

SOFAS

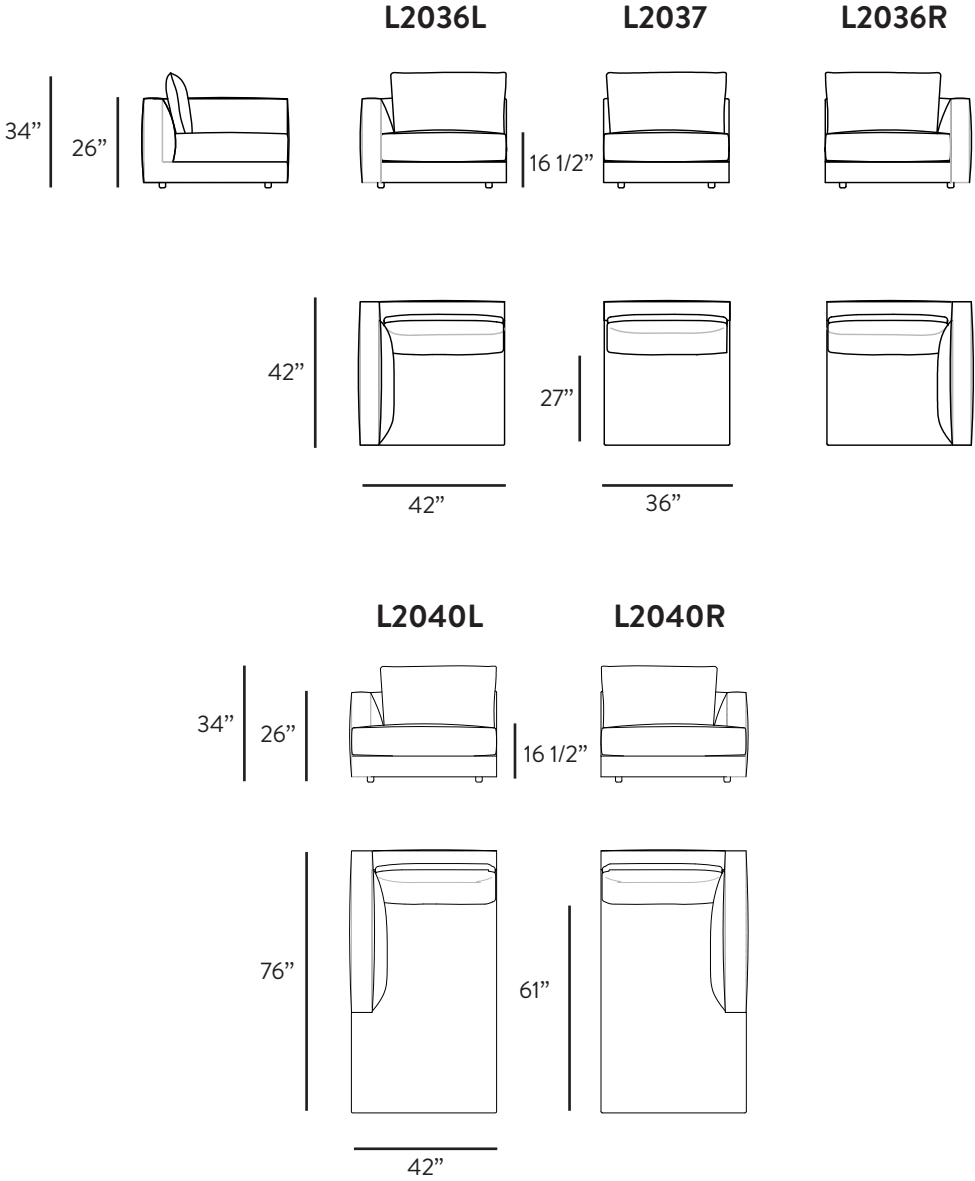

Edward

L2000

SOFAS

L2026L

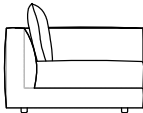

L2027

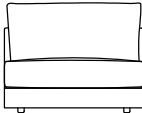

L2026R

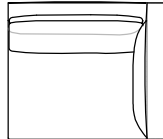
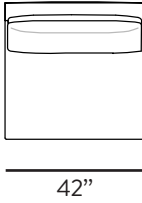
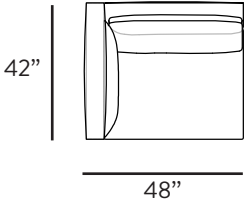
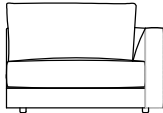

L2046L



L2046R

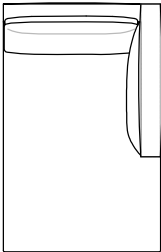
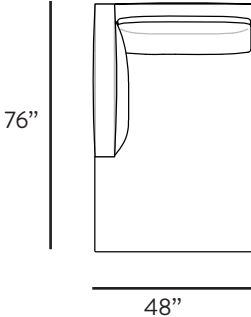
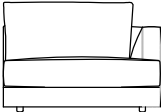

Edward

L2000

SOFAS

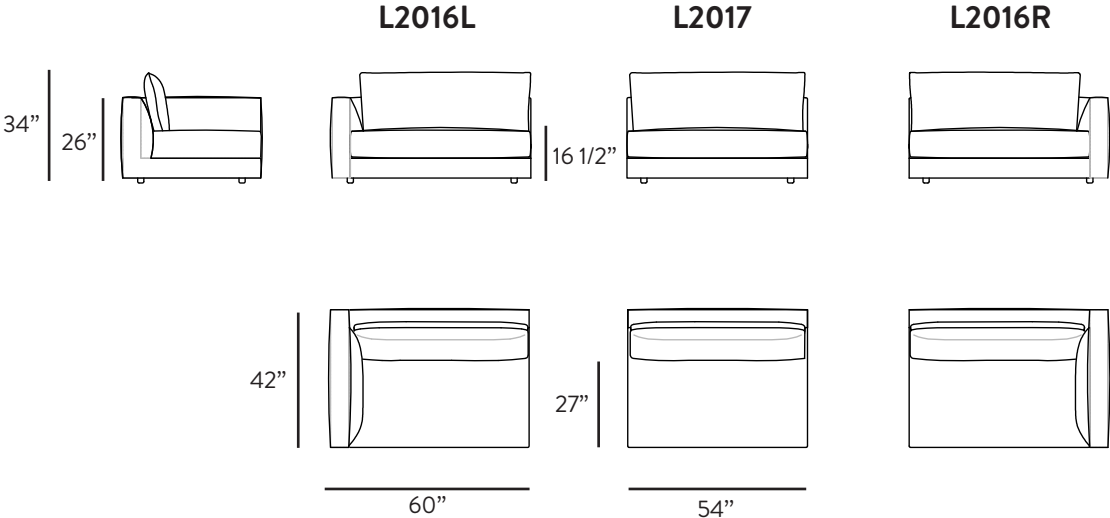

CORNERS

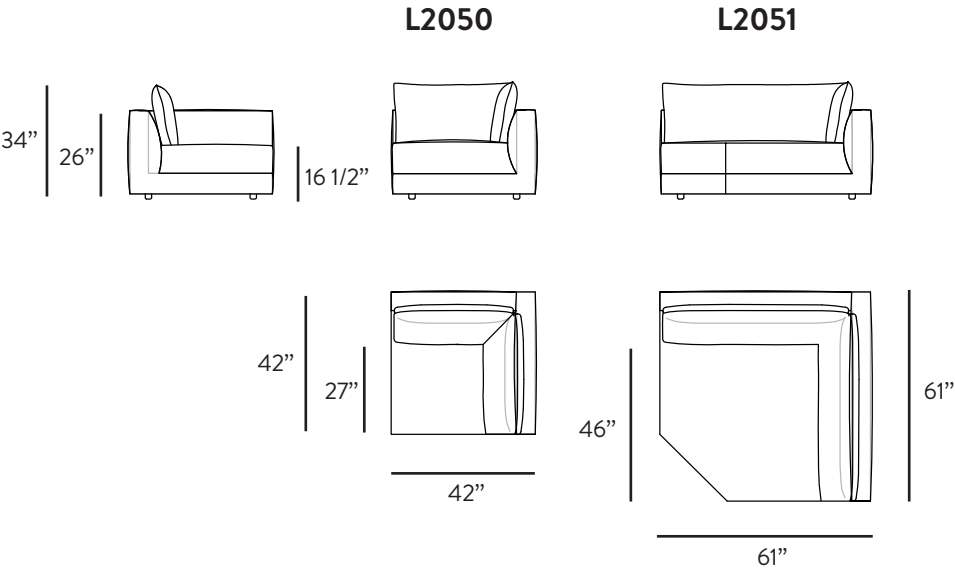

Edward

L2000

OTTOMANS

L2006



16 1/2"

L2007

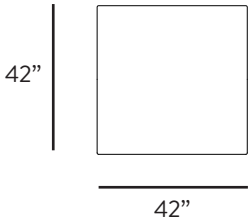

CUSHIONS

L2054



32"

L2056



38"

L2058

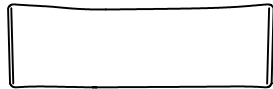

50"

Back cushions

20"

L2055



28"

L2057



34"

L2059



46"

Lumbar cushions

17"

L1058



16"

Small cushion

16"

Edward

L2000

FURNITURE OPTIONS

2072

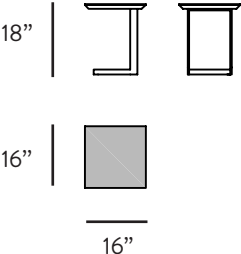

2051

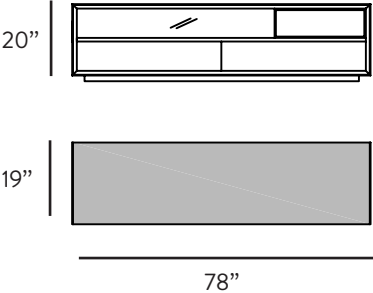

2070

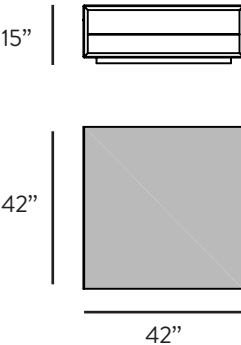

2071

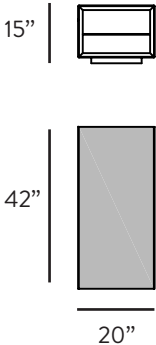

2077

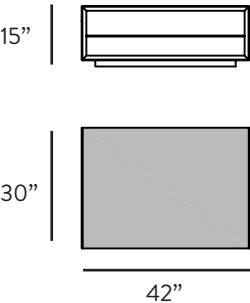

2078

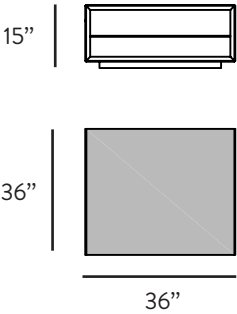

Edward

L2000

CONFIGURATIONS

E-1

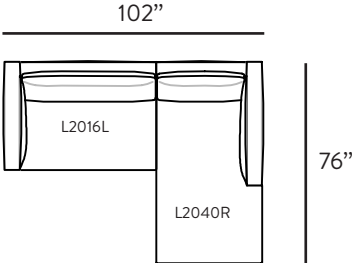

E-2

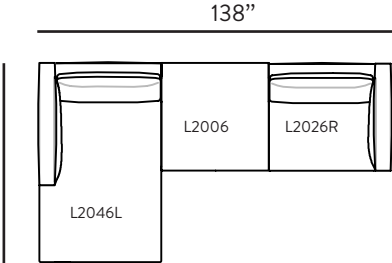

E-3

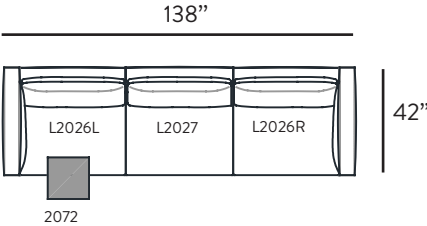

E-4

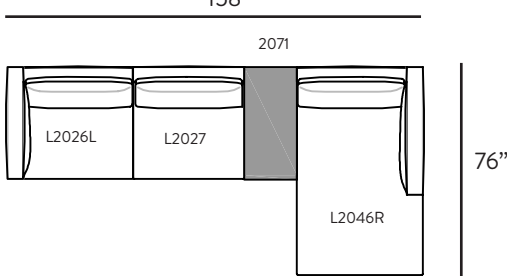

E-5

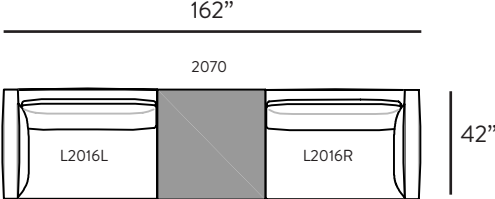

E-6

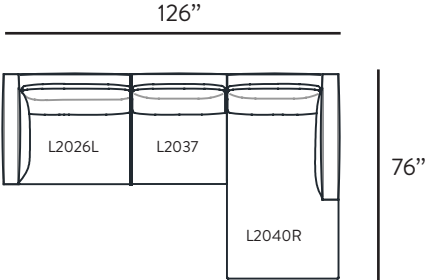

E-7

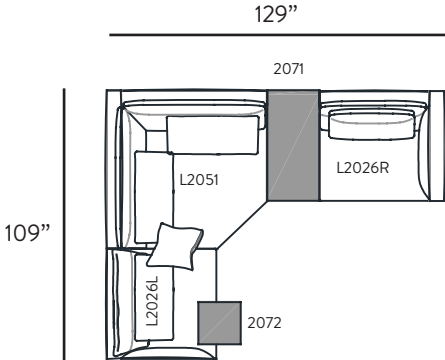

E-8

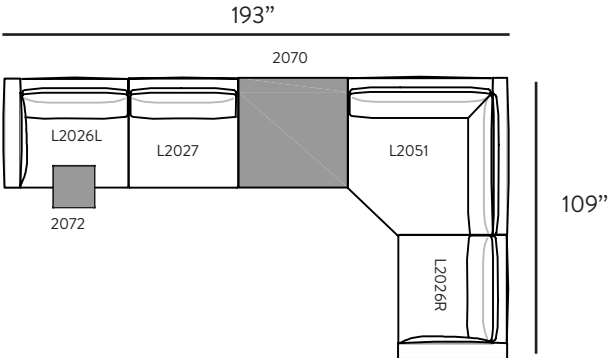

Edward

L2000

CONFIGURATIONS

E-9

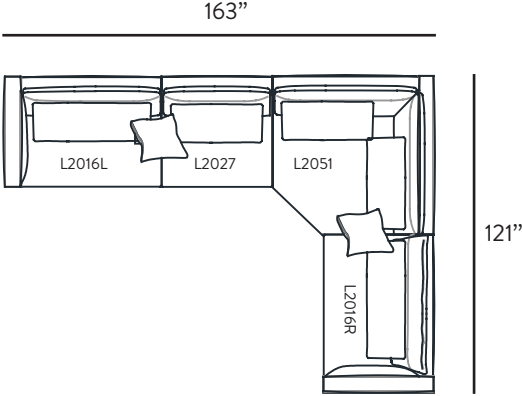

E-10

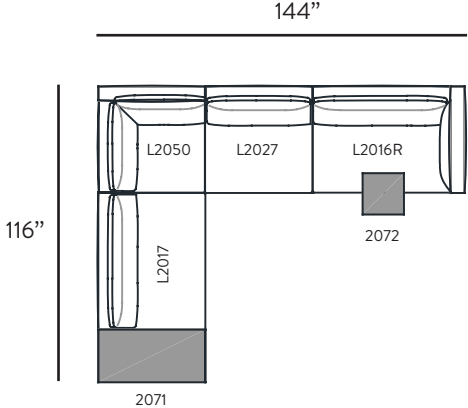

E-11

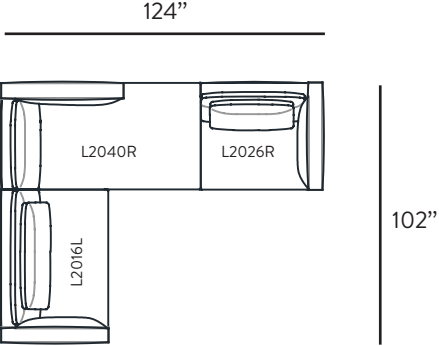

E-12

